

F 015 962 021
Stand | 10-09-14
Issue | 11-03-08

Fig./Abb. 1

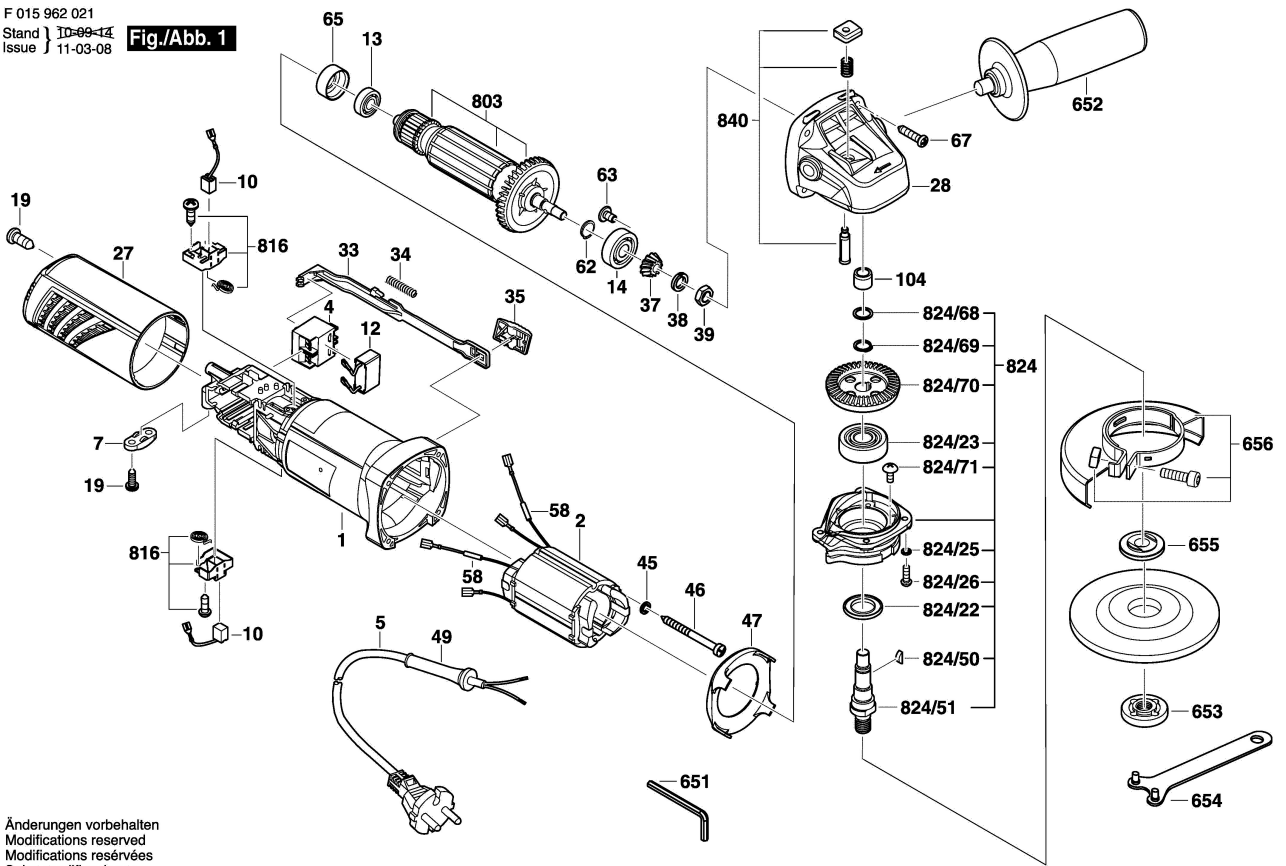

Änderungen vorbehalten
Modifications reserved
Modifications réservées
Salvo modificaciones