

F 015 981 621

Stand | 13-09-27
Issue | 14-03-26

Fig./Abb. 1

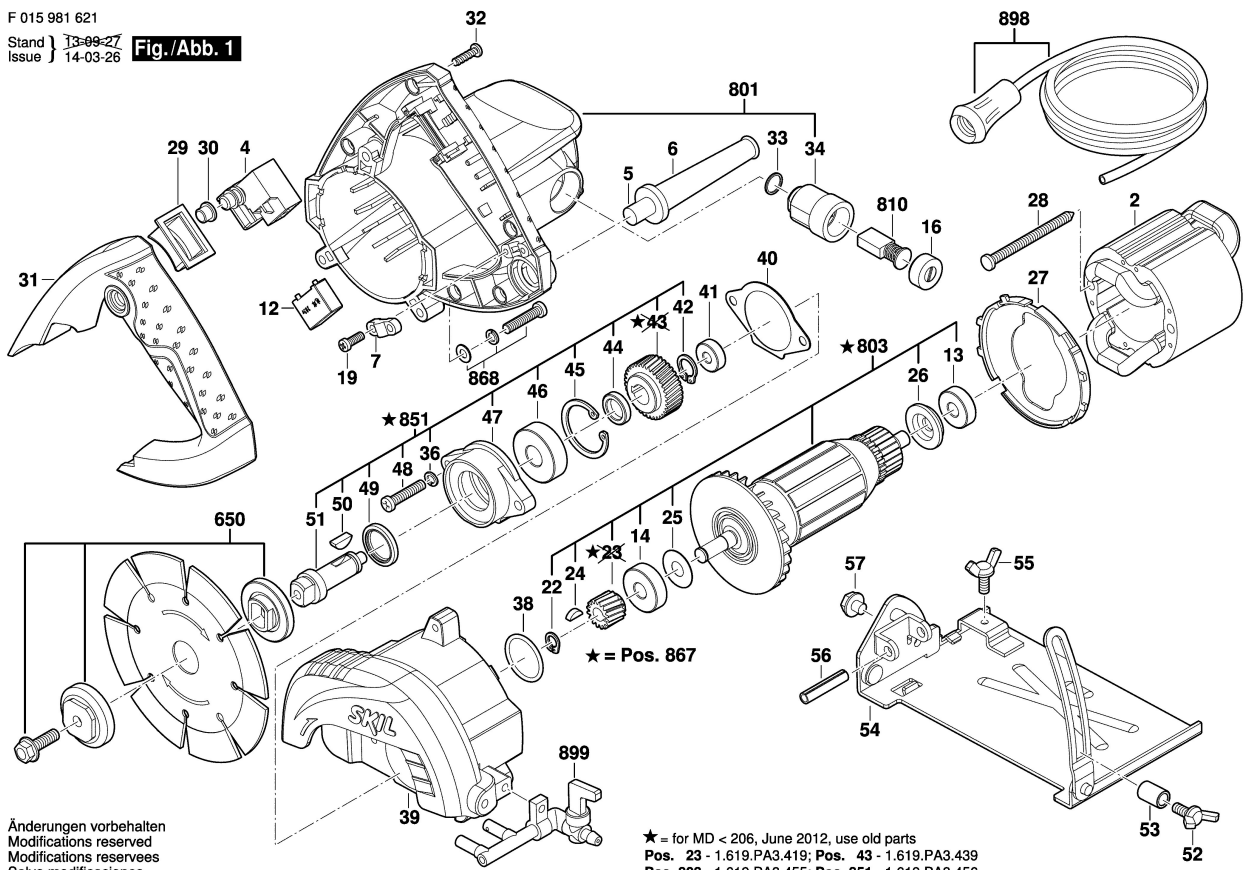

Änderungen vorbehalten
Modifications reserved
Modificaciones reservadas
Salvo modificaciones