

F 015 981 722

Stand | 13-10
Issue | 14-01-22

Fig./Abb. 1

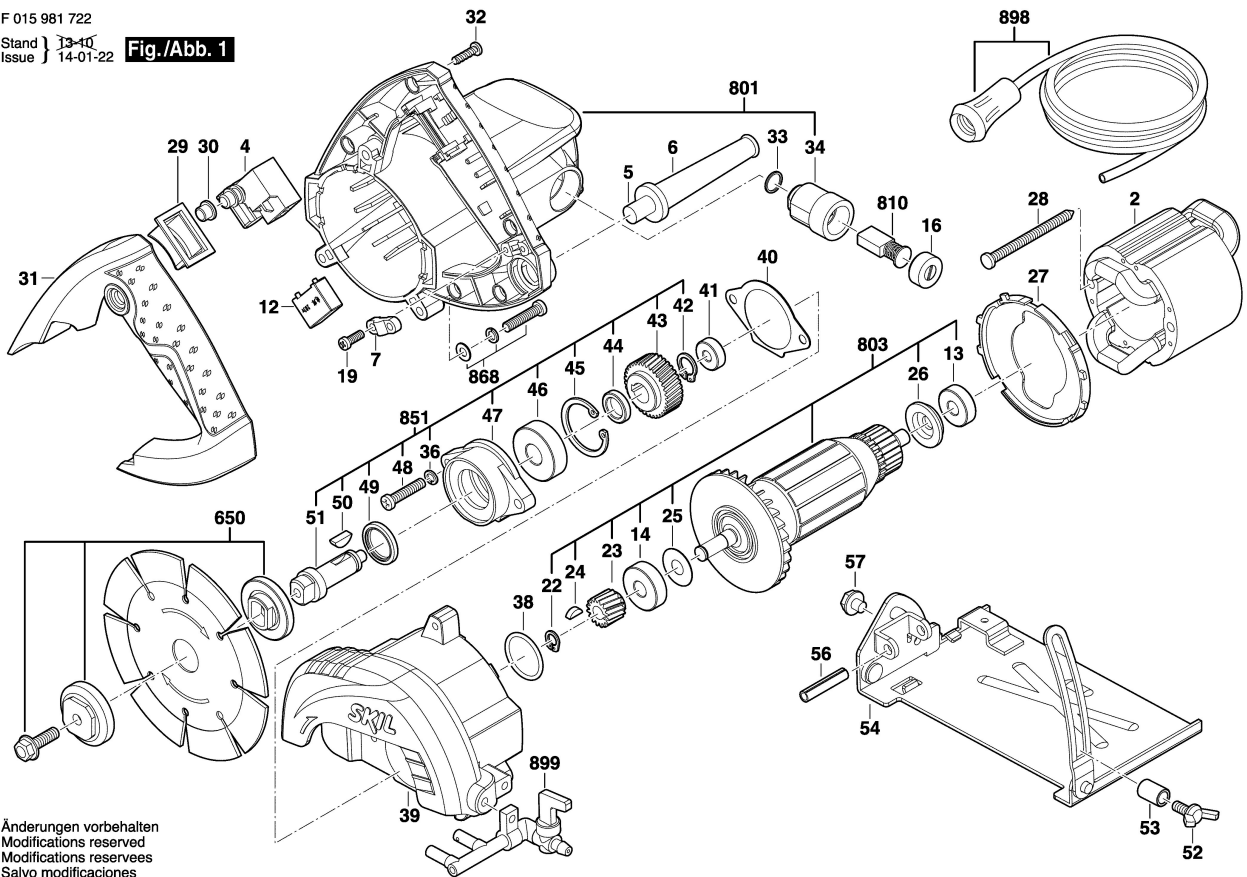

Änderungen vorbehalten
Modifications reserved
Modifications reserves
Salvo modificaciones