

F 015 981 722

Stand | 13-10  
Issue | 14-01-22

**Fig./Abb. 1**

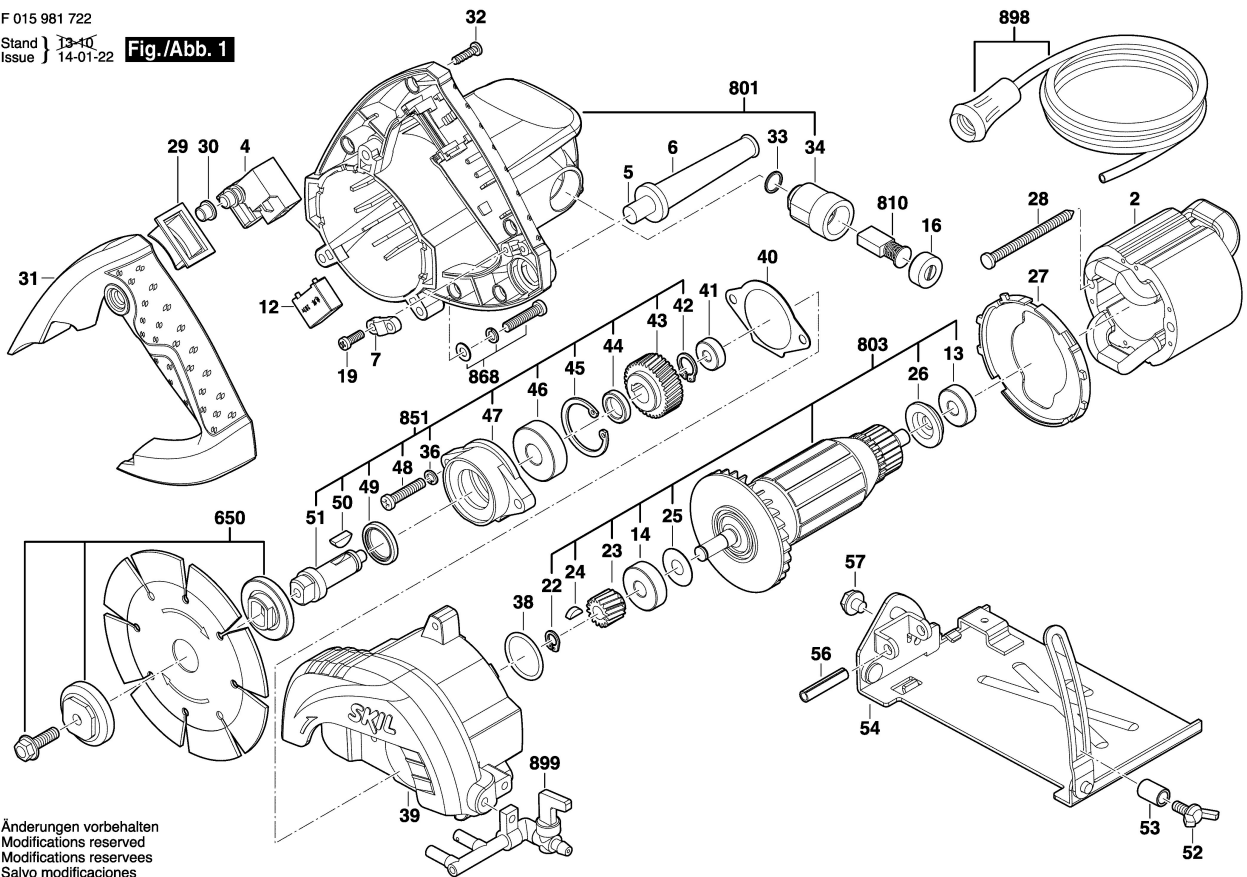

Änderungen vorbehalten  
Modifications reserved  
Modifications reserves  
Salvo modificaciones