

F 015 985 021

Stand } 11-03-01
Issue }

Fig./Abb. 1

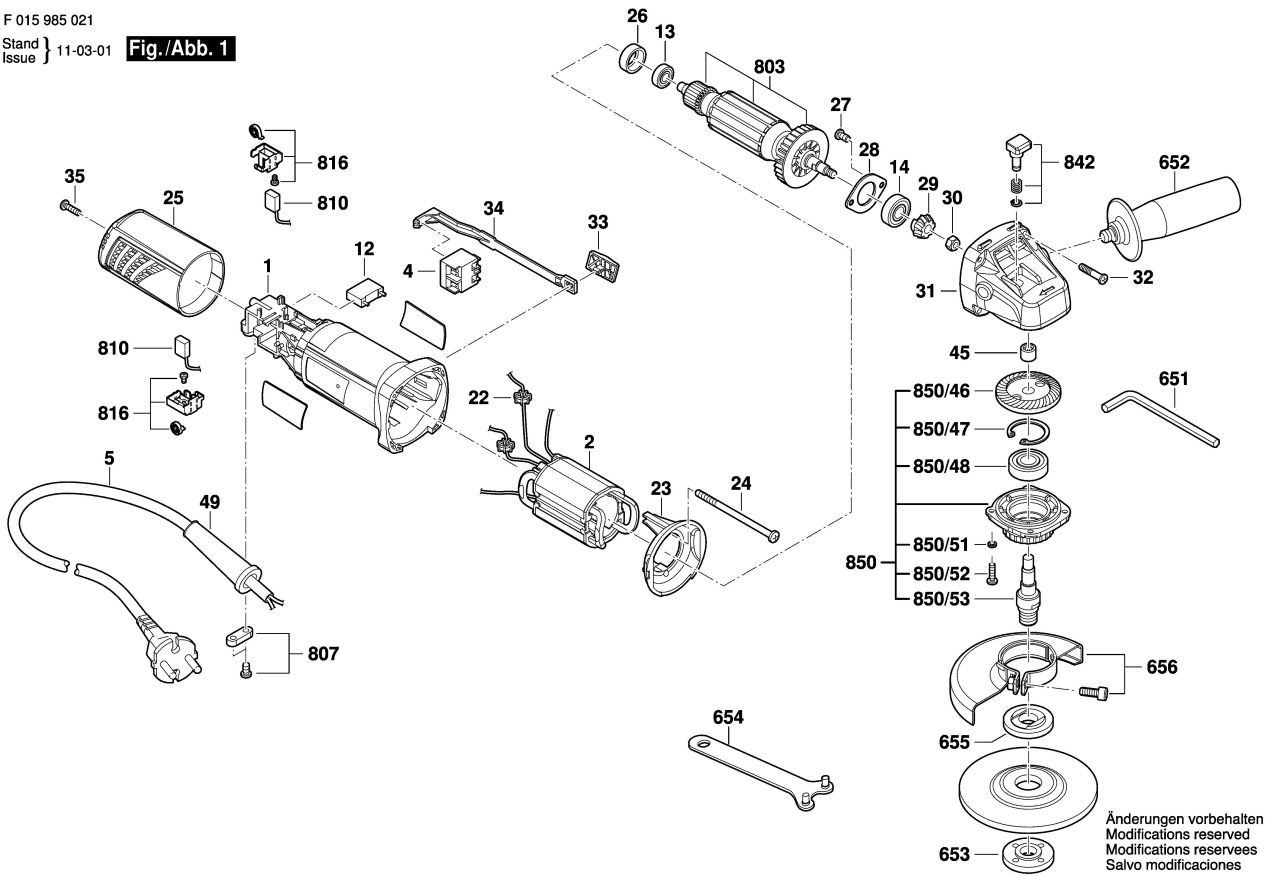

Anderungen vorbehalten
Modifications reserved
Modificaciones reservadas
Salvo modificaciones