

F 015 995 511

Stand } 11-09-26 **Fig./Abb. 1**

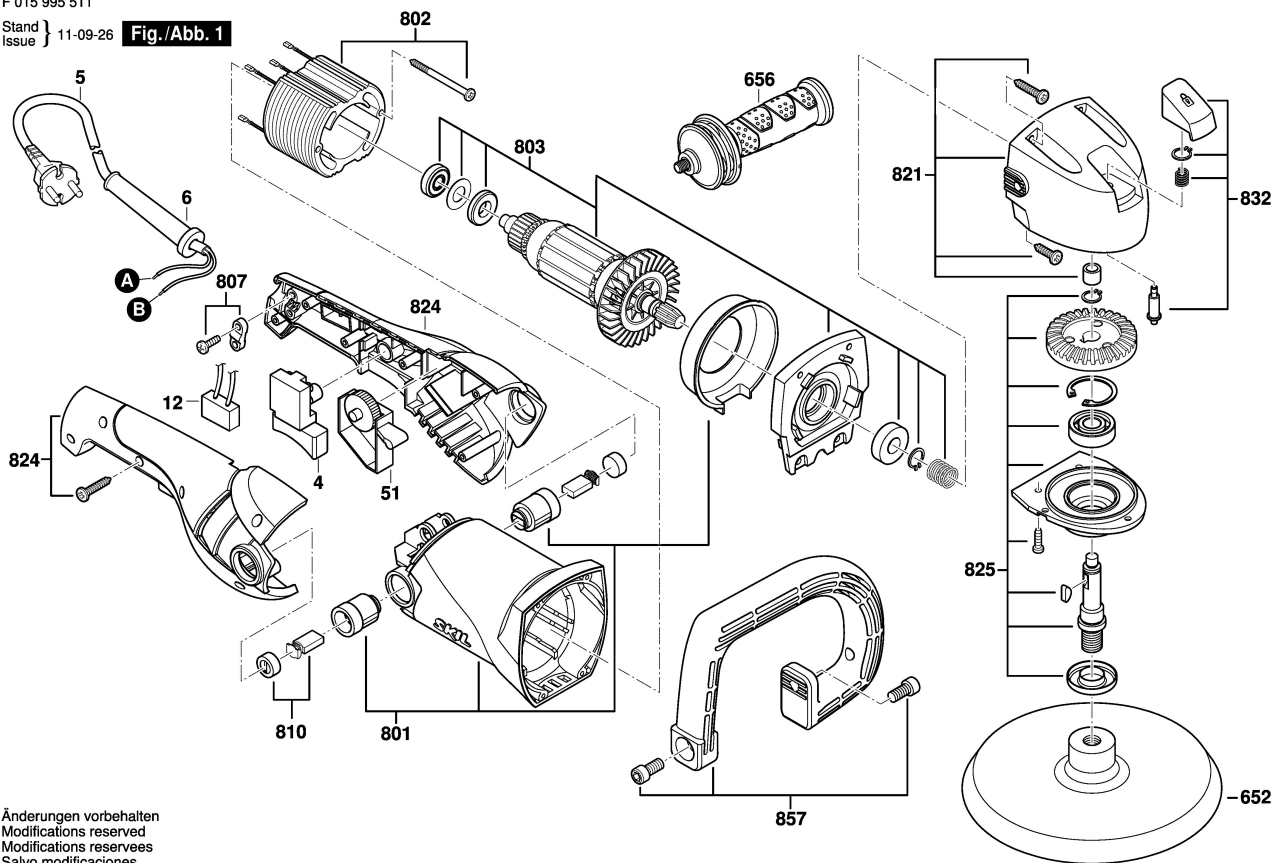

Änderungen vorbehalten
Modifications reserved
Modifications reserves
Salvo modificaciones