

# Models 453 and 473

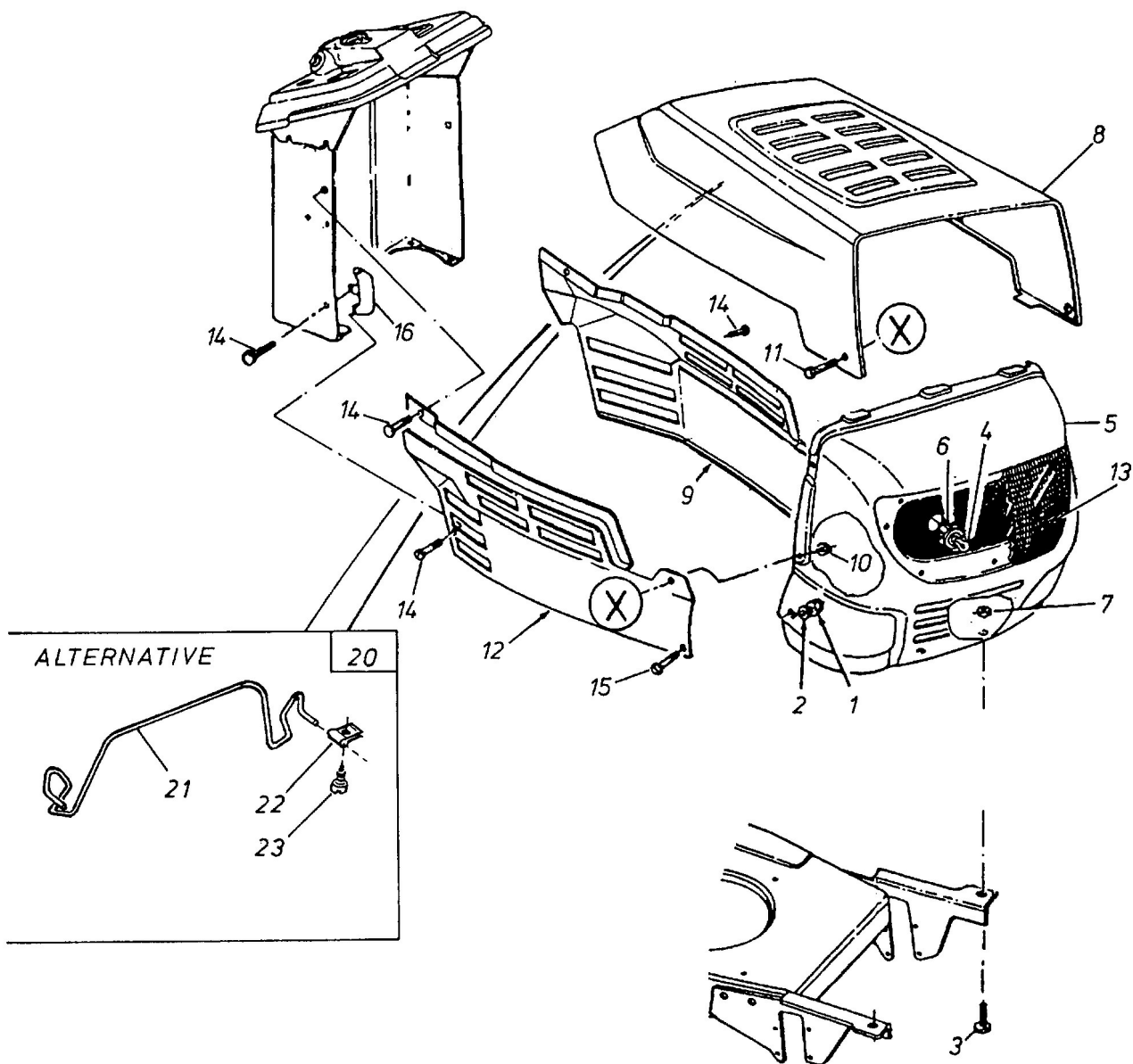

E3-01298 A