

Grass Catcher

Model 400 - TRANSMATIC (E-Deck 36")

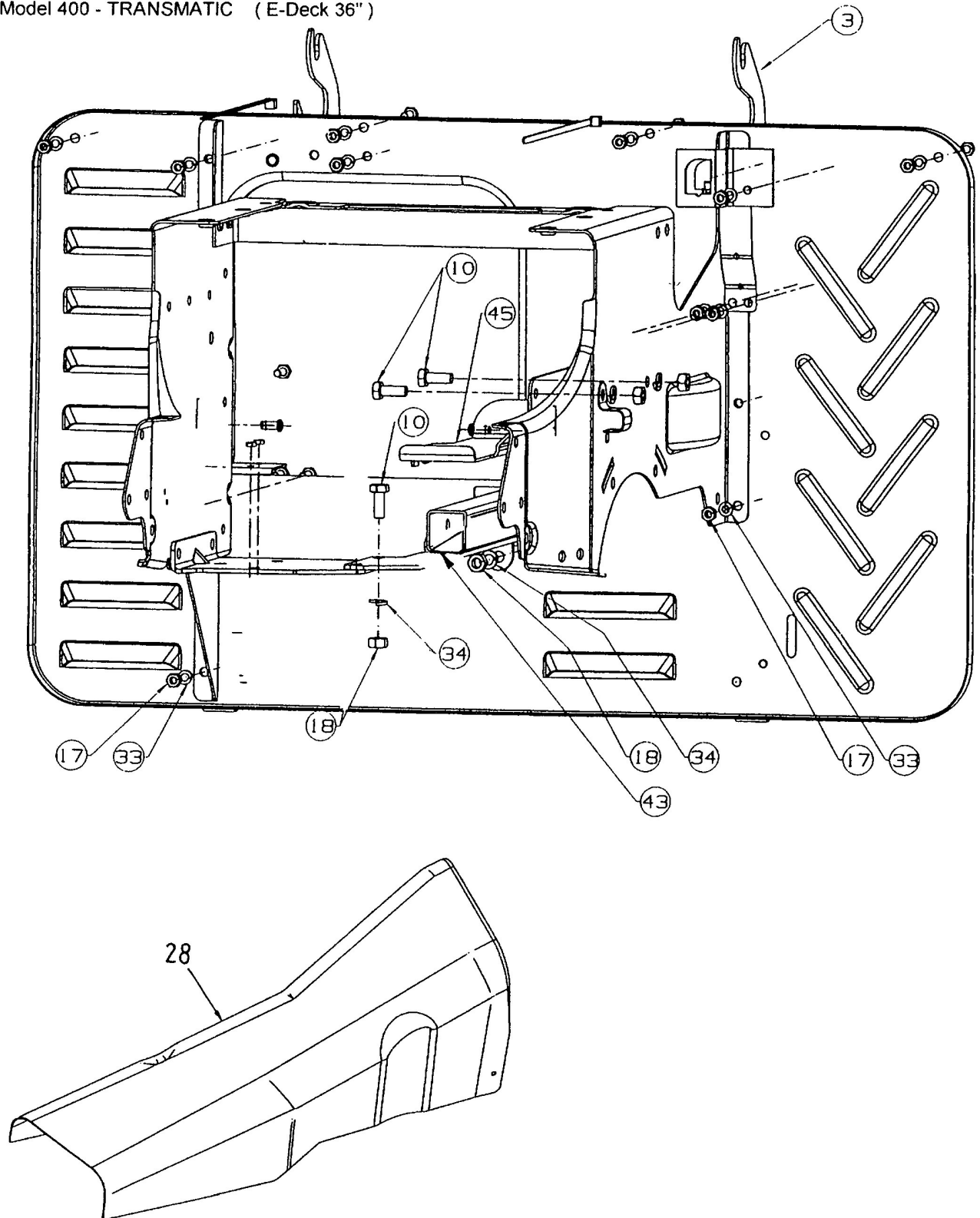

E3-01439A

BLATT 2 VON 3