

500-er

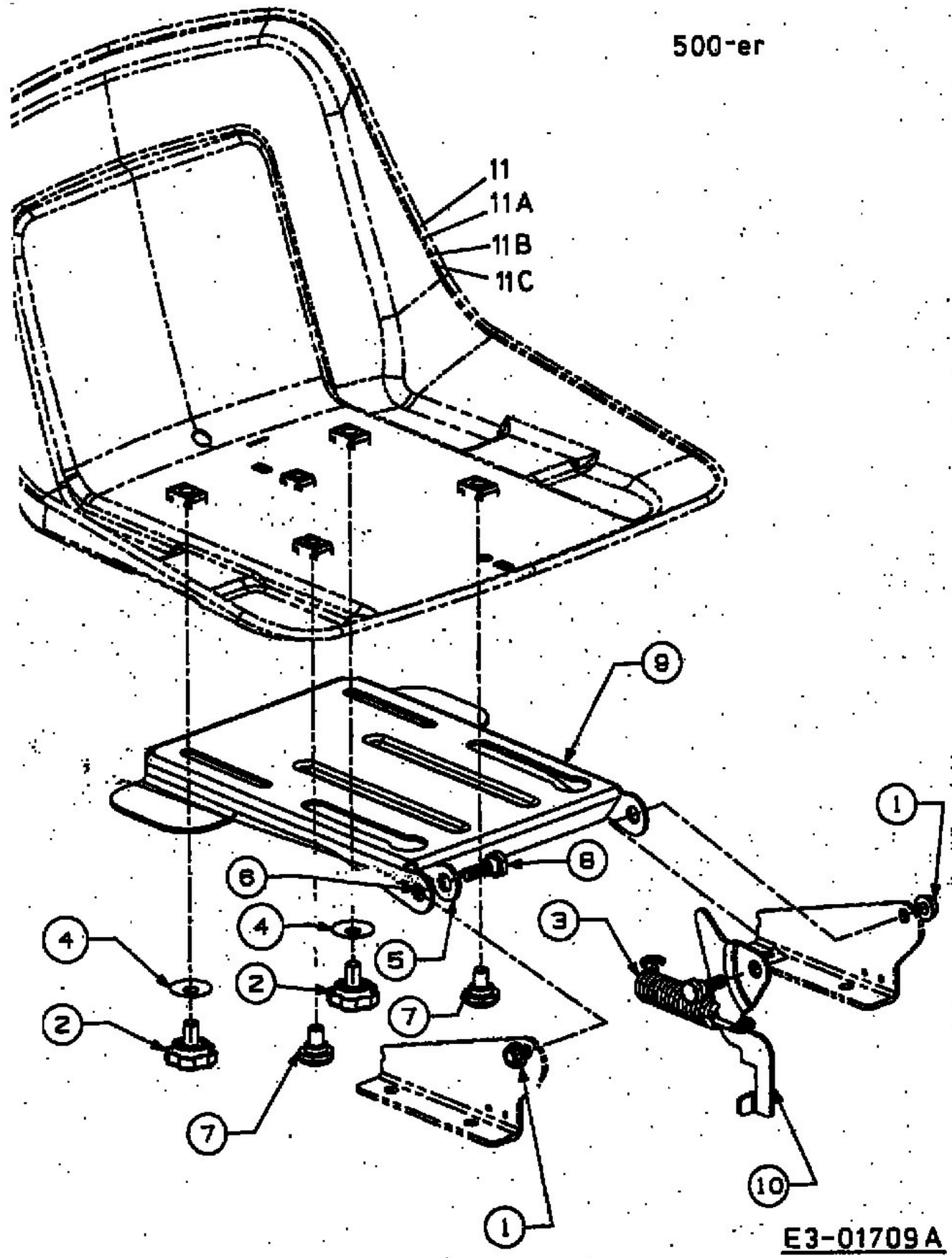

E3-01709 A