

THROTTLE LIMITER TO BE PLACED BETWEEN DASH AND THE THROTTLE BRACKET.

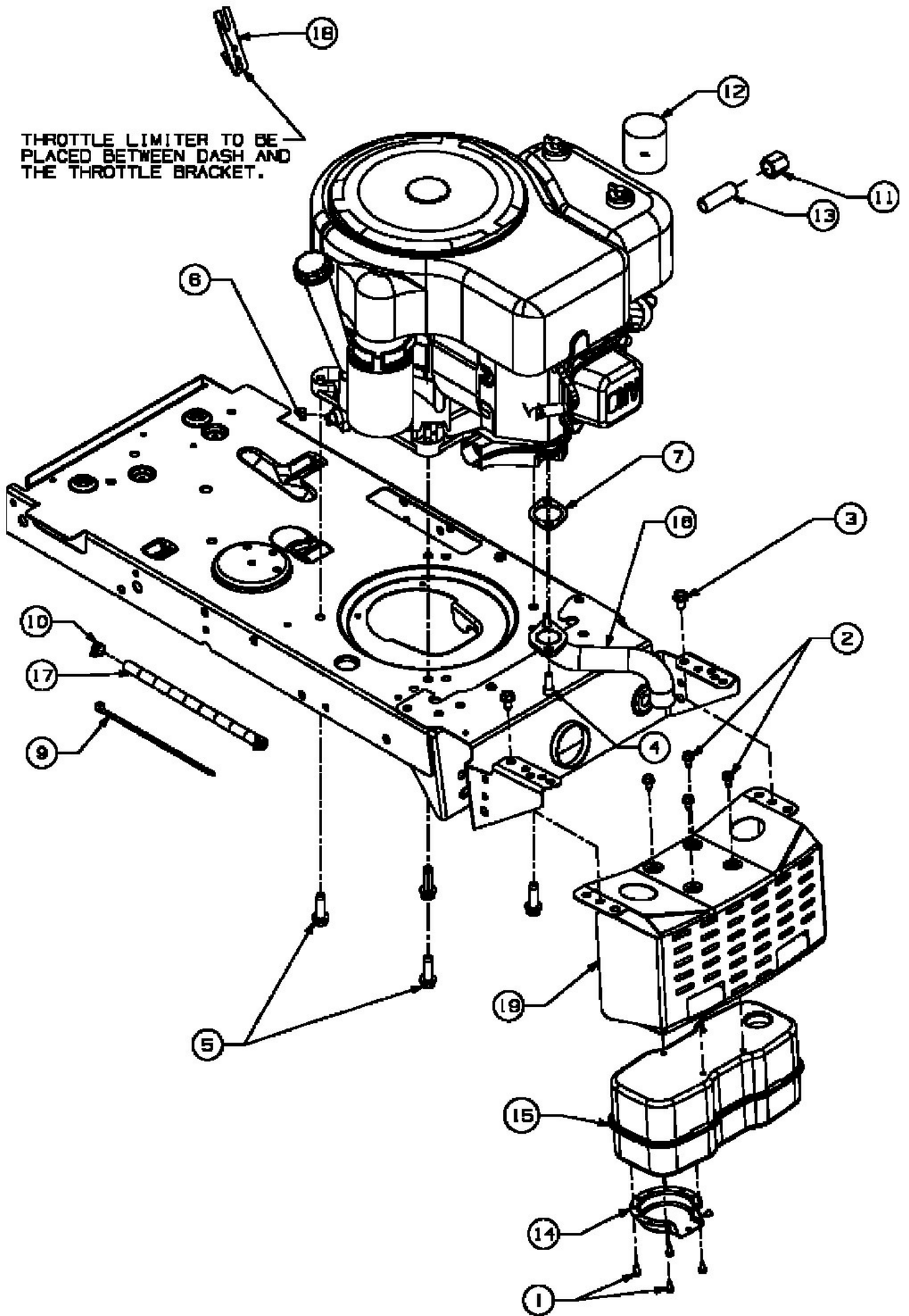

E3-02751A-01

