

THROTTLE LIMITER TO BE  
PLACED BETWEEN DASH AND  
THE THROTTLE BRACKET.

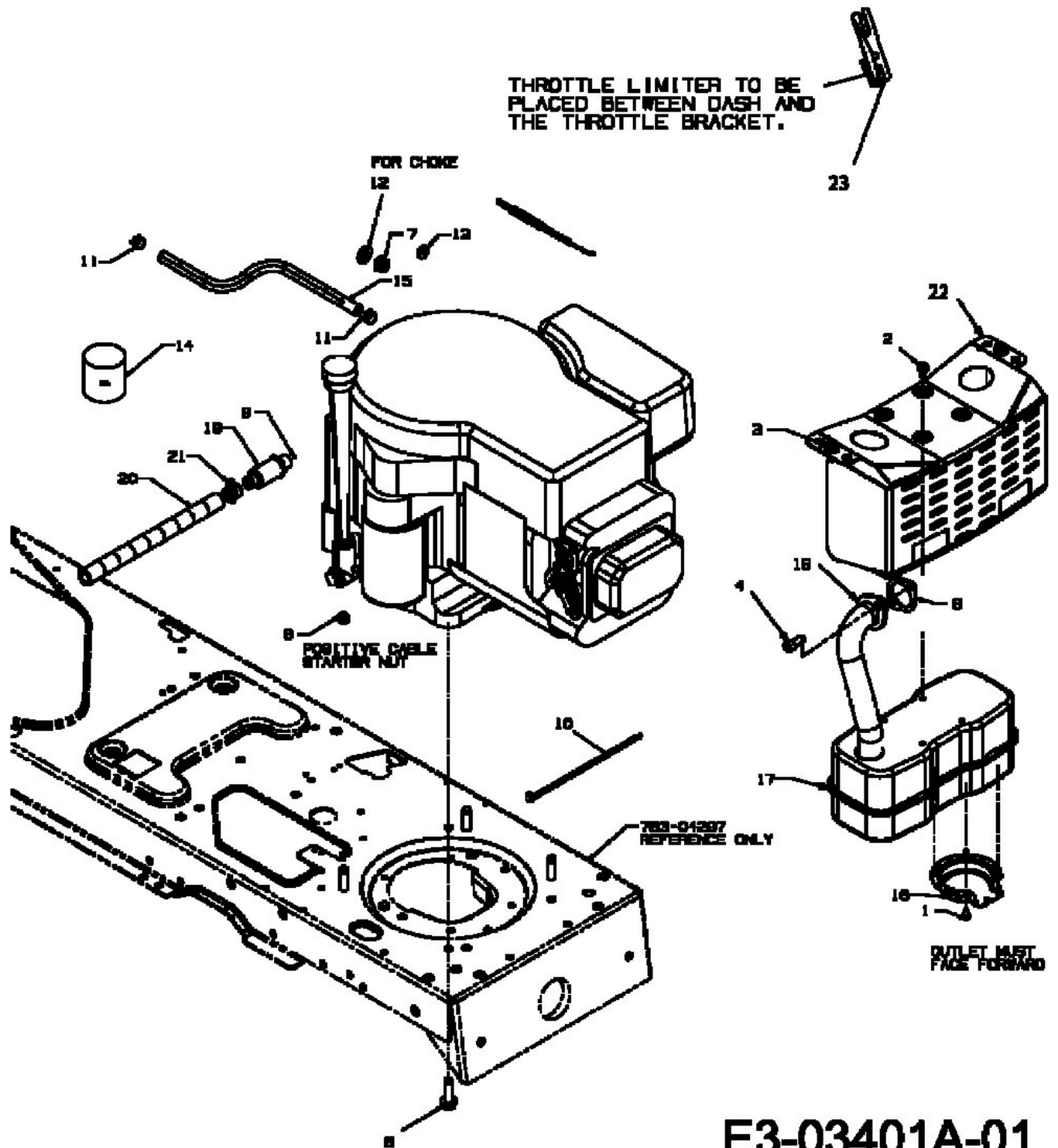

E3-03401A-01