

THROTTLE LIMITER TO BE
PLACED BETWEEN DASH
AND THE THROTTLE BRACKET.

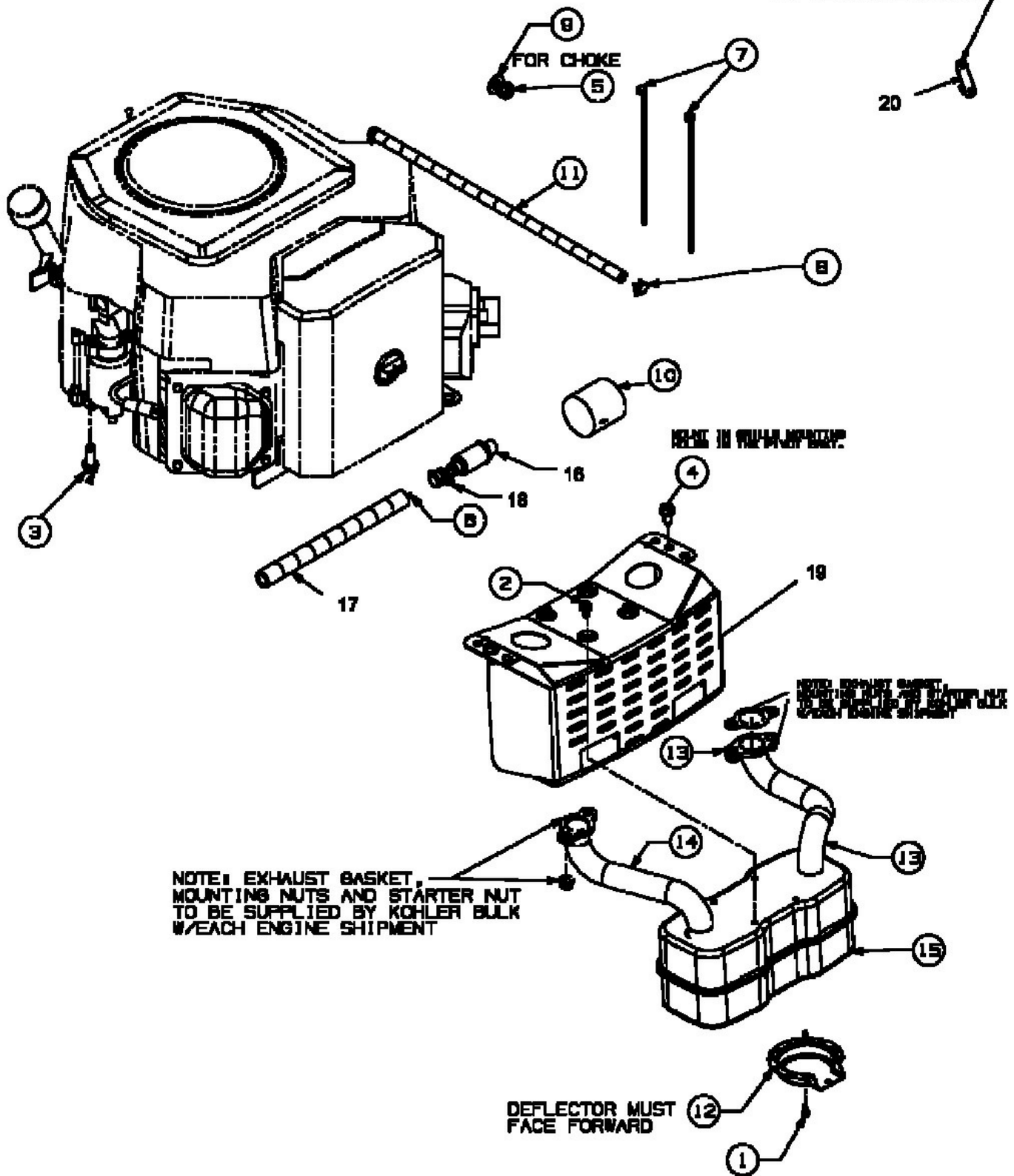

E3-03407A-01