

Zubehör / Option

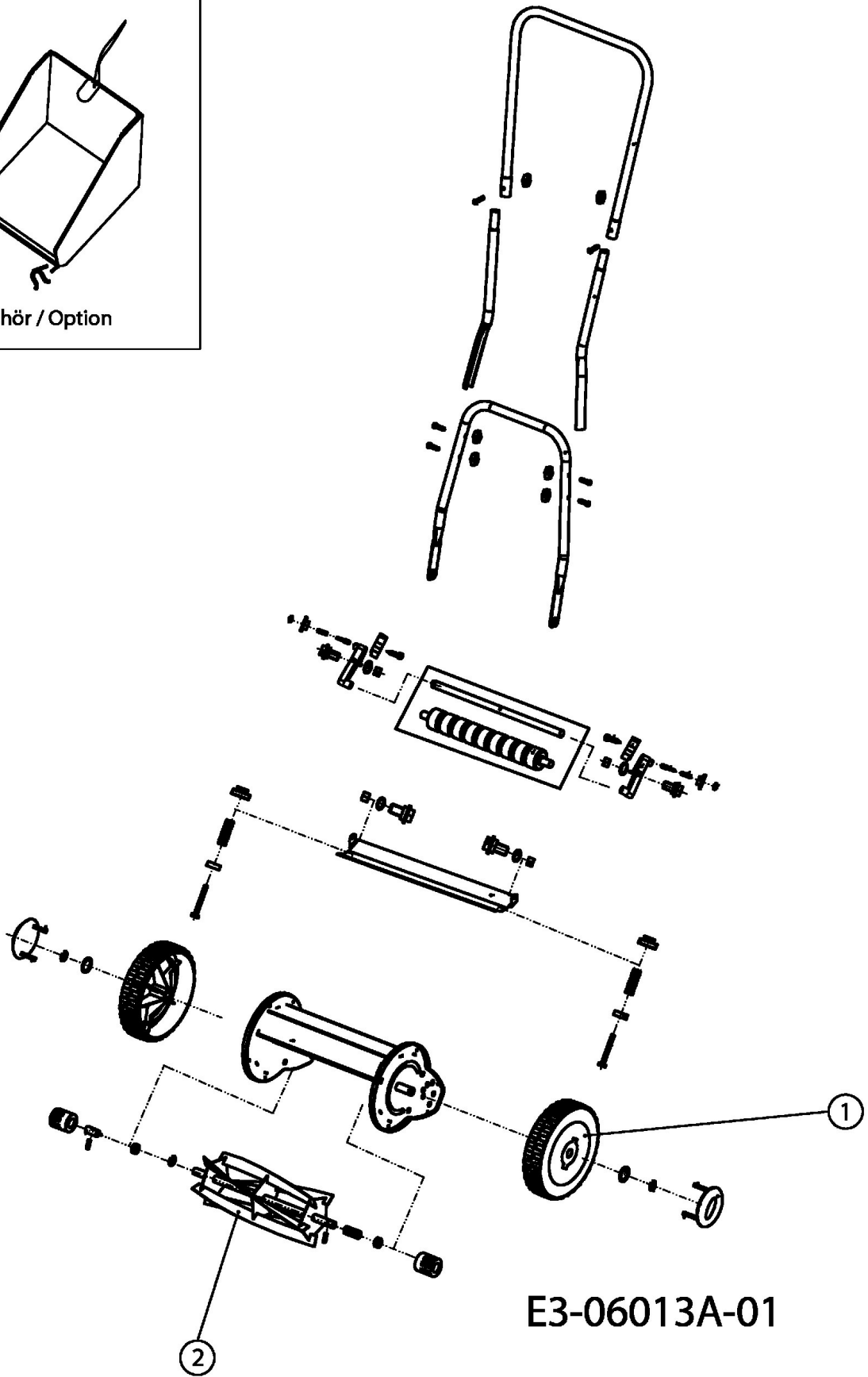

E3-06013A-01