

Zubehör / Option

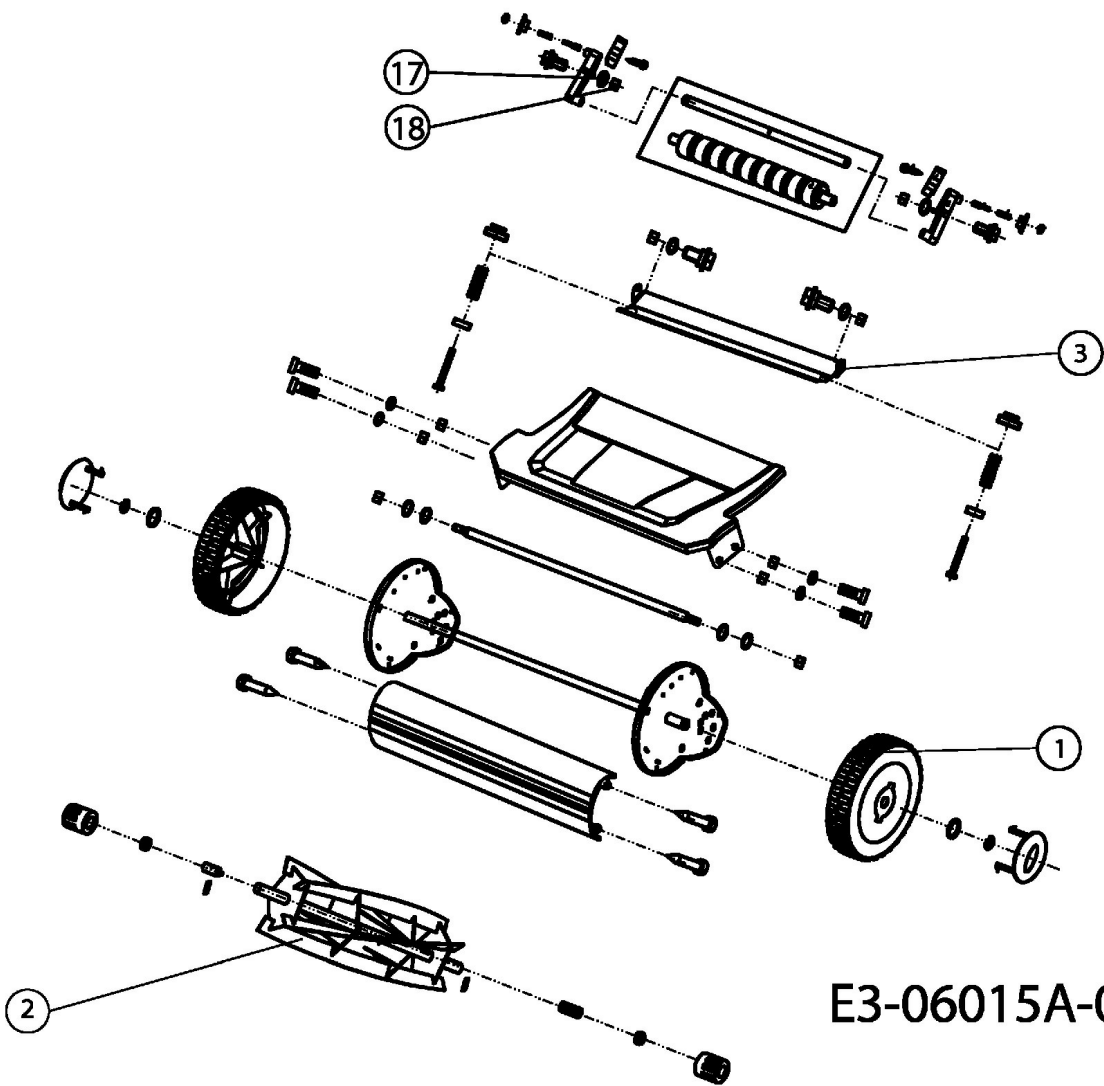
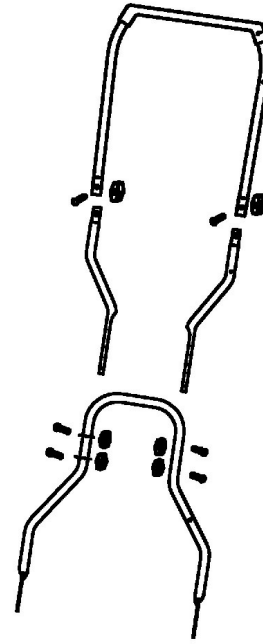

E3-06015A-01