

46

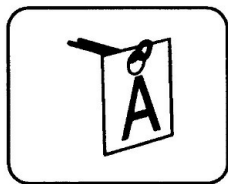

856

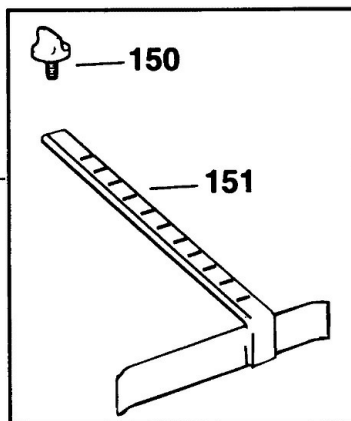

150

151